

4

3

2

1

ZONE	REV	DESCRIPTION	ECN	DATE	APVD
	1	INITIAL RELEASE			
	2	CHANGED TABLE ON SHEET 2		12/16/15	

TOP

SIDE

BOTTOM

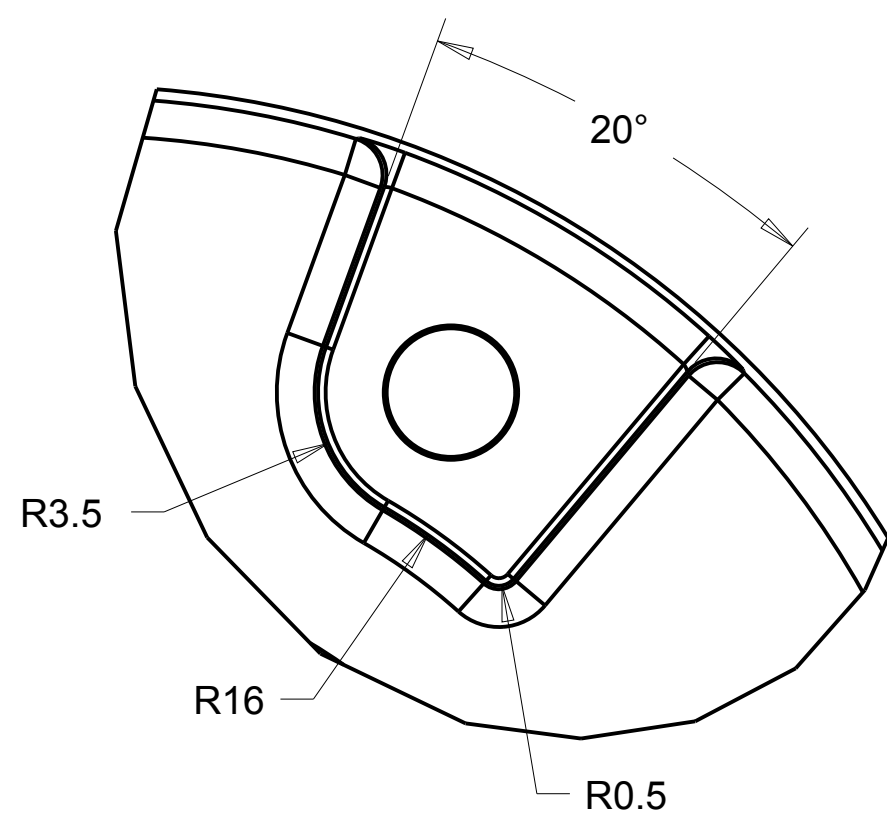
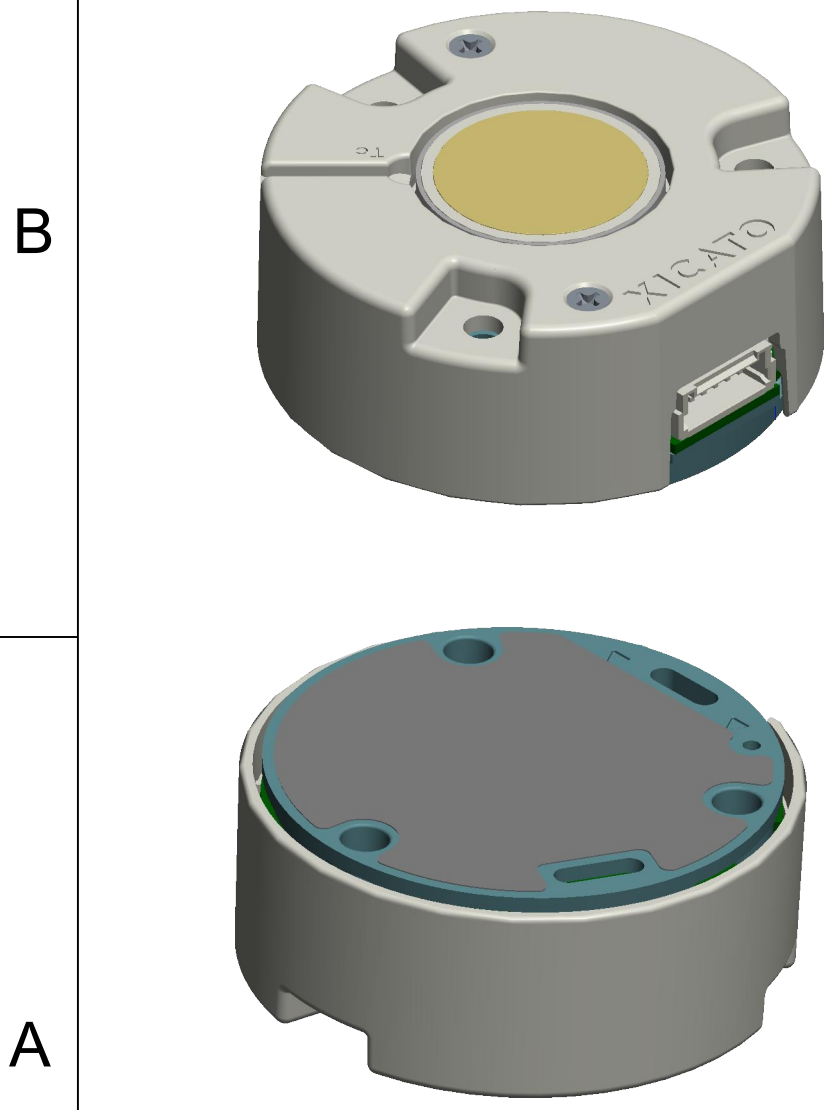
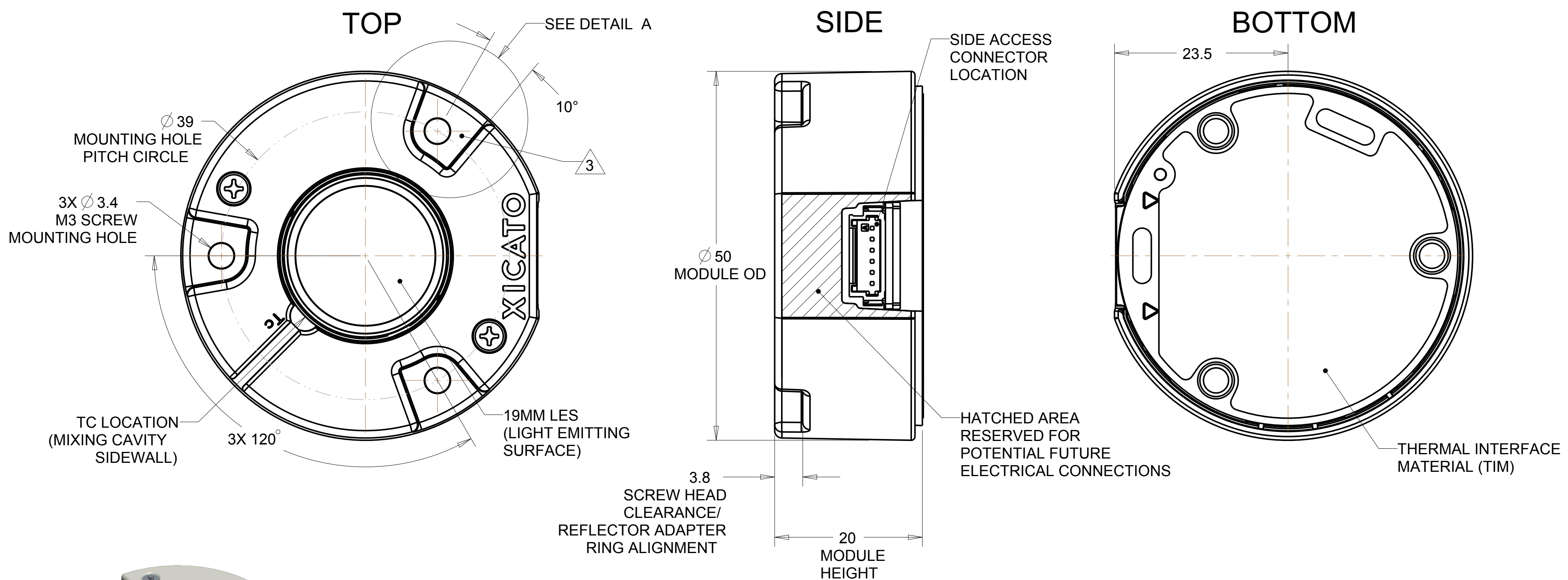

DETAIL A SCALE 5.000

NOTES: UNLESS OTHERWISE SPECIFIED

- 1. XXX
- 2. XXX
- 3. FEATURE FOR REFLECTOR ADAPTER RING
- 4. WIRE HARNESS SUPPLIED BY XICATO OR AVNET, PART # XSA-331
- 5. MODULE IP RATING: IP20
- 6. SUGGESTED ASSEMBLY TORQUE = .56 NM (5IN-LB)
- 7. ASSEMBLE WITH M3 X 25MM SCREWS AND M3 LOCKWASHERS

**-CONFIDENTIAL-**

THIS DOCUMENT IS AND CONTAINS CONFIDENTIAL AND TRADE SECRET INFORMATION OF XICATO INC.

THIS DOCUMENT IS LOANED FOR LIMITED PURPOSES ONLY AND REMAINS THE PROPERTY OF XICATO INC. IT IS TO BE RETURNED UPON REQUEST AND IN ALL EVENTS UPON COMPLETION OF PURPOSE OF THE LOAN.

NEITHER IT NOR THE INFORMATION IT CONTAINS MAY BE REPRODUCED, USED, OR DISCLOSED TO PERSONS NOT HAVING A NEED TO KNOW CONSISTENT WITH THE PURPOSE OF THE LOAN WITHOUT WRITTEN CONSENT OF XICATO INC.

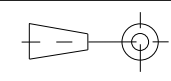

DATE:	XX	XICATO INC
DSR:	XX	
REL.:	XX	TITLE <b>19MM XIM INTERFACE</b>
PROD.:	XX	
ENGR.:	XX	DWG SIZE C
CHKD:	XX	PART NUMBER
CHKD:	XX	SCALE: 2.500
		REV. 2
		SHEET 1 OF 2

4

3

2

1

4

3

2

1

ZONE	REV	DESCRIPTION	ECN	DATE	APVD

### XIMCV SIDE ACCESS DETAIL 6 PIN MINI CT CONNECTOR

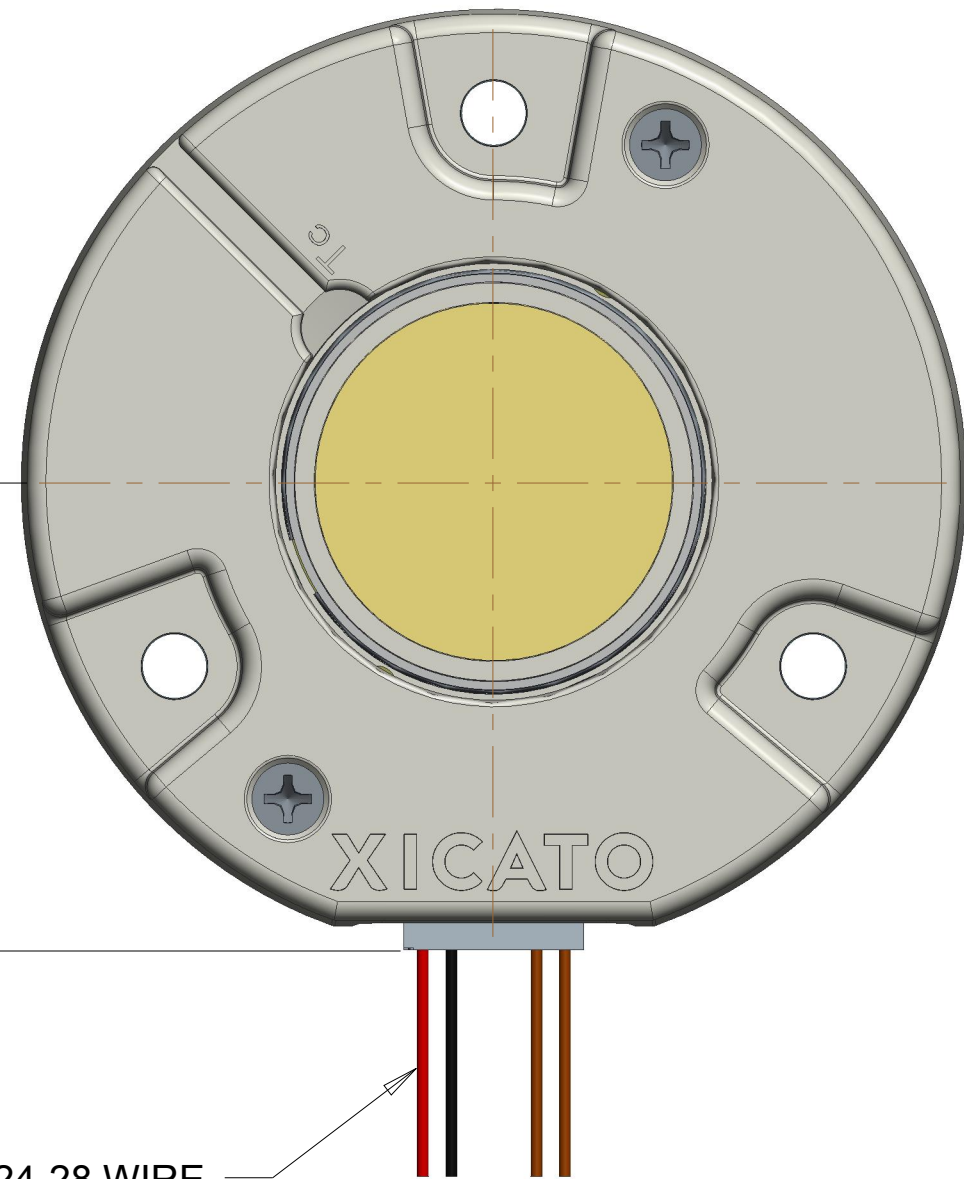

24.8  
TO BACK  
OF MATING  
CONNECTOR

AWG 24-28 WIRE  
(600V RATED)

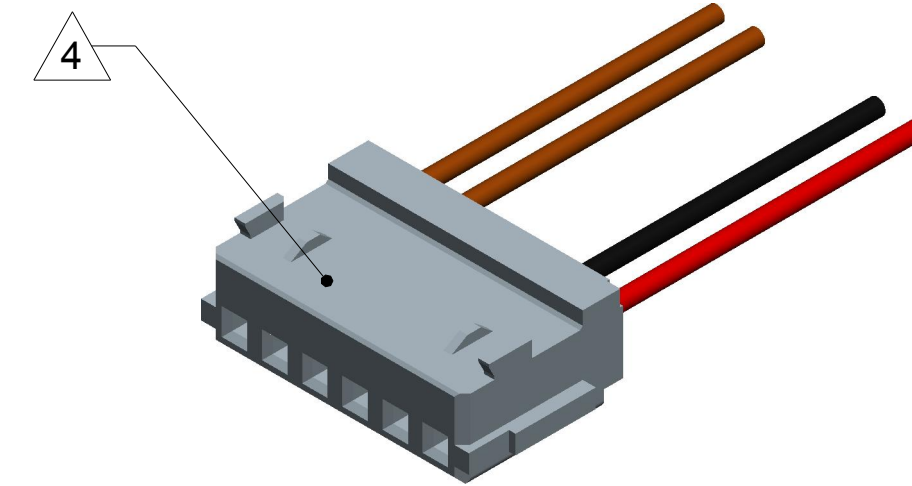

XIM-CV PIN OUT						
PIN#	WIRE COLOR	FUNCTION		AWG	RATING	LENGTH
1	RED	+ 48V POWER		24 (1.12 MM MAX INULATION OD)	1200mA	600 MM
2	BLACK	- 48V POWER		24 (1.12 MM MAX INULATION OD)	1200mA	600 MM
3	DNU	XICATO RESERVED		N/A	N/A	N/A
4	DNU	XICATO RESERVED		N/A	N/A	N/A
5	VIOLET	1-10V	DIM +	24 (1.12 MM MAX INULATION OD)	50V 250mA	600 MM
		DALI	CONTROL 1			
6	GREY	1-10V	DIM -	24 (1.12 MM MAX INULATION OD)	50V 250mA	600 MM
		DALI	CONTROL 2			

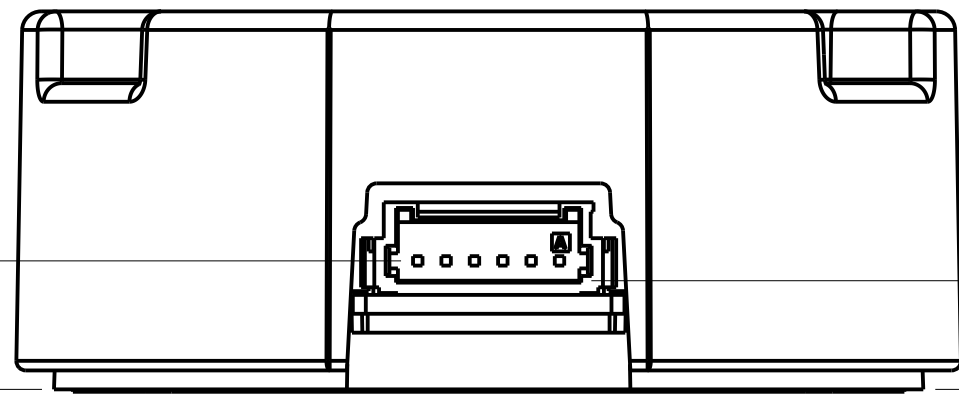

6.85

5.8  
TO BASE OF  
MATING CONNECTOR

**-CONFIDENTIAL-**

THIS DOCUMENT IS AND CONTAINS CONFIDENTIAL AND TRADE SECRET INFORMATION OF XICATO INC.

THIS DOCUMENT IS LOANED FOR LIMITED PURPOSES ONLY AND REMAINS THE PROPERTY OF XICATO INC. IT IS TO BE RETURNED UPON REQUEST AND IN ALL EVENTS UPON COMPLETION OF PURPOSE OF THE LOAN.

NEITHER IT NOR THE INFORMATION IT CONTAINS MAY BE REPRODUCED, USED, OR DISCLOSED TO PERSONS NOT HAVING A NEED TO KNOW CONSISTENT WITH THE PURPOSE OF THE LOAN WITHOUT WRITTEN CONSENT OF XICATO INC.

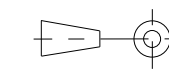

DATE:	XX
DSR:	XX
REL.:	XX
PROD.:	XX
ENGR.:	XX
CHKD:	XX
CHKD:	XX

XICATO INC

TITLE  
**19MM XIM INTERFACE**

DWG SIZE C	PART NUMBER	REV. 2
SCALE: 2.500		SHEET 2 OF 2

4

3

2

1